

VANTAGE

V4142-0001











Vintan





S-4981

	
	
	
	
	





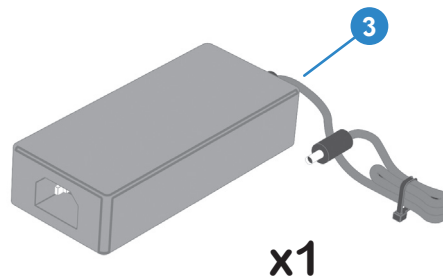
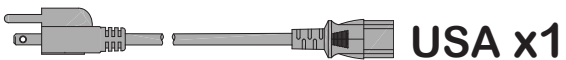
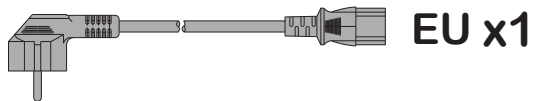
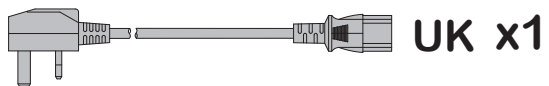
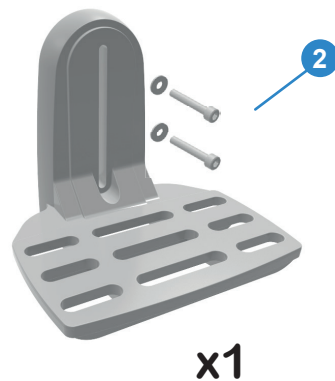

V4142-1007

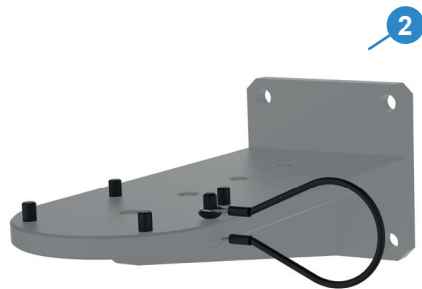

V4142-1008



V4142-1009

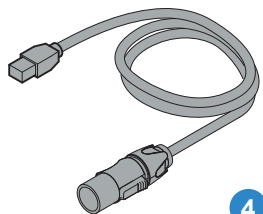

V4142-5005

V4142-5006

V4142-5011

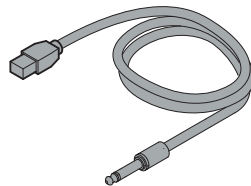

V4142-5008

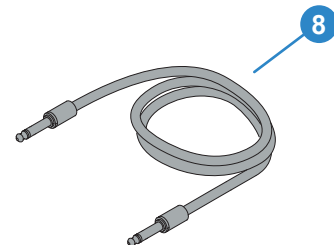

V4142-5009



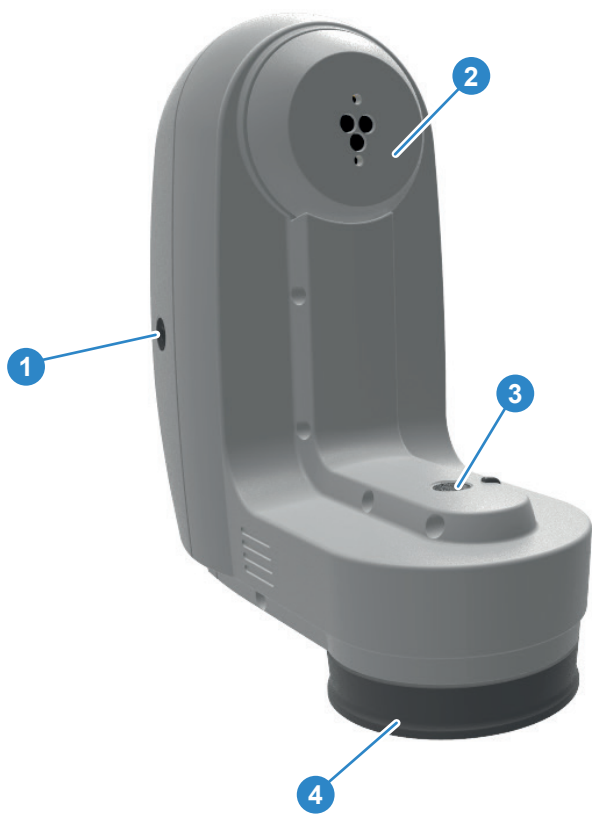

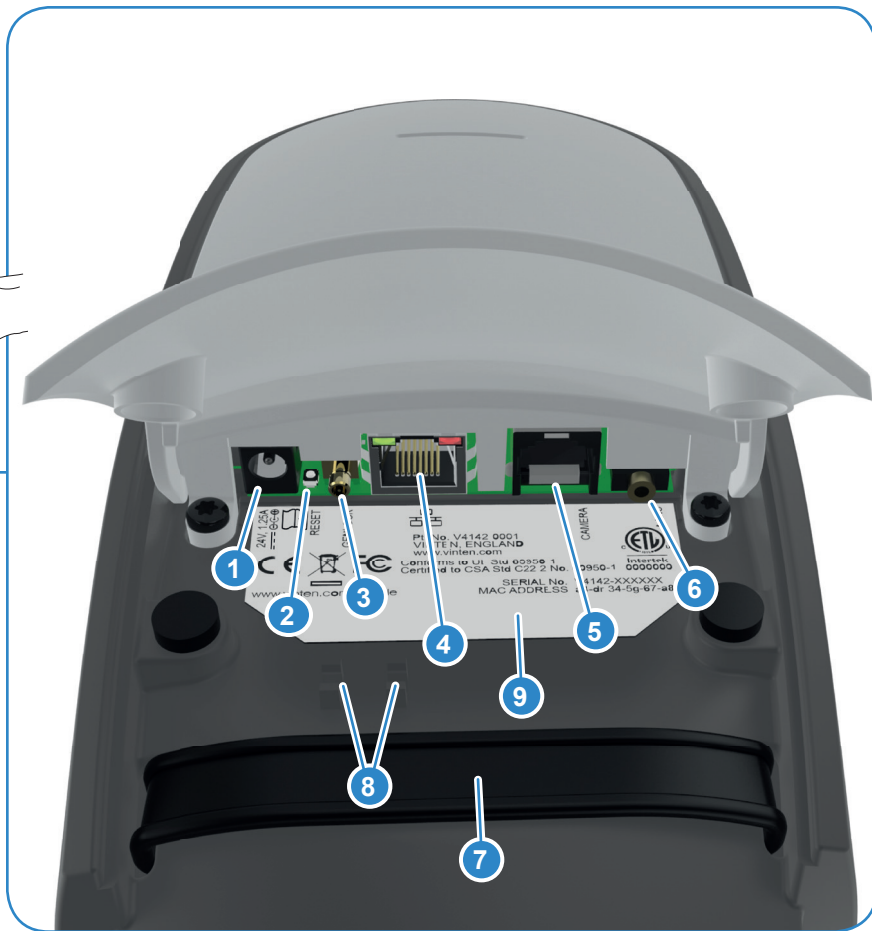



1

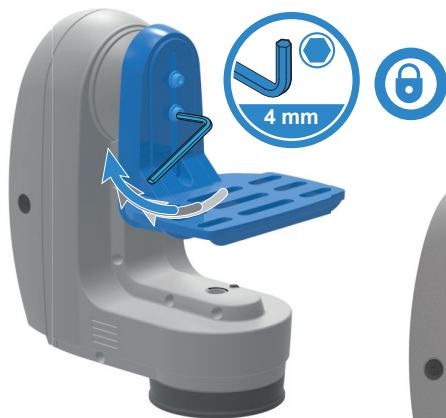
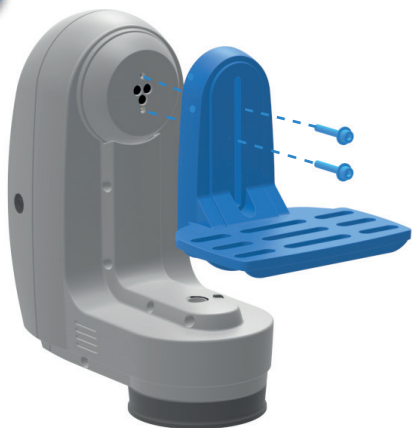

2

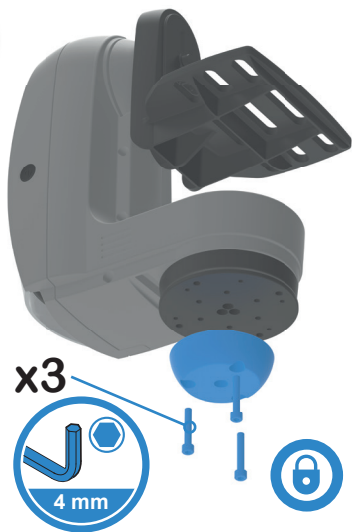

3



6

1



2

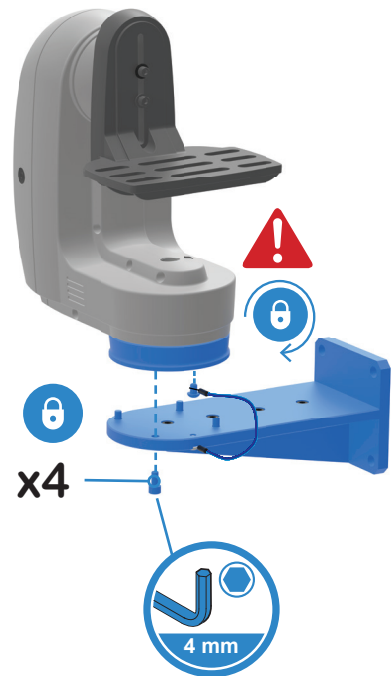

3





1

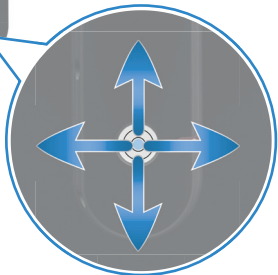

2

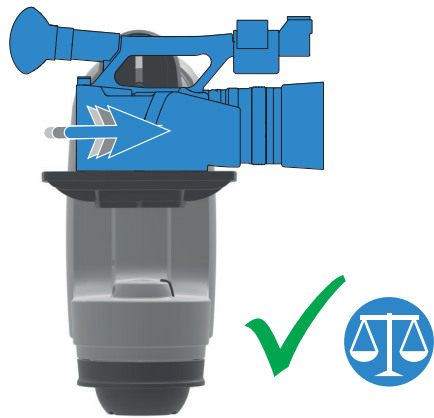
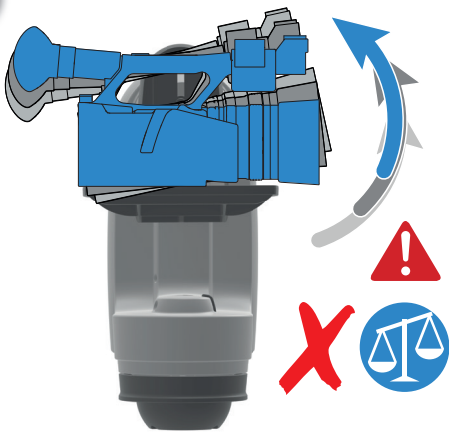

3

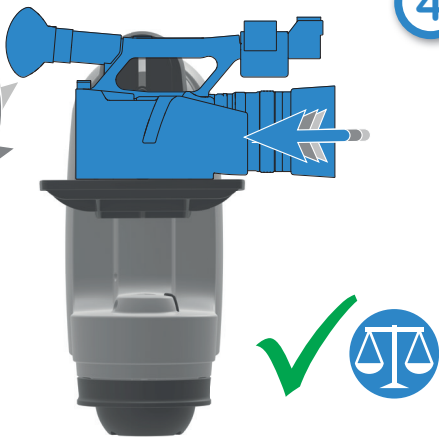
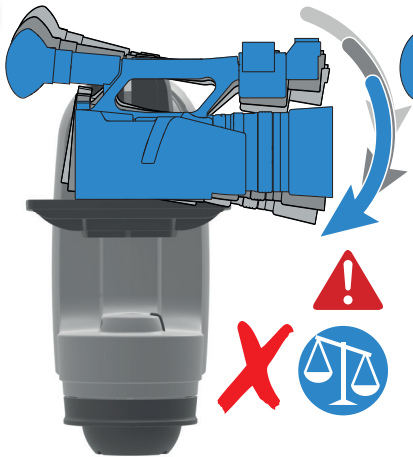

4

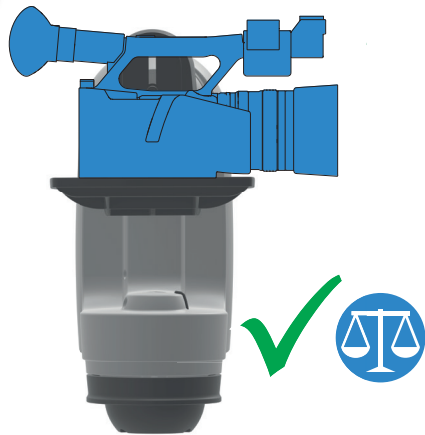



30°

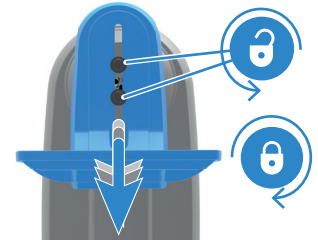
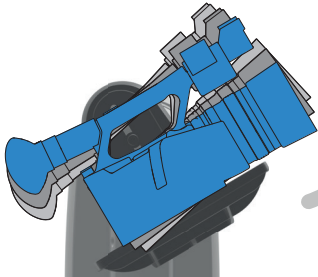
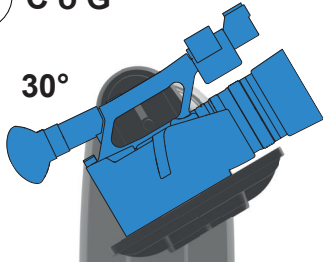

1



=

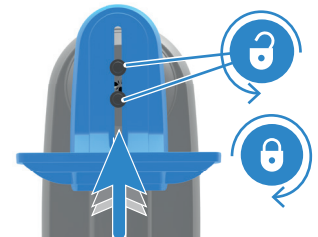
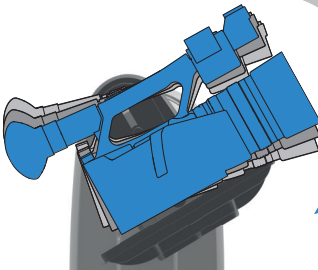
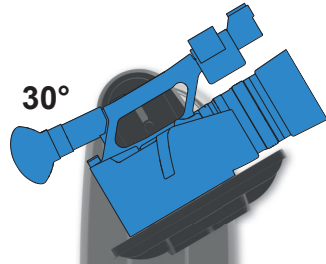

2



=





S-4981

24 V dc 1.25 A



Genlock

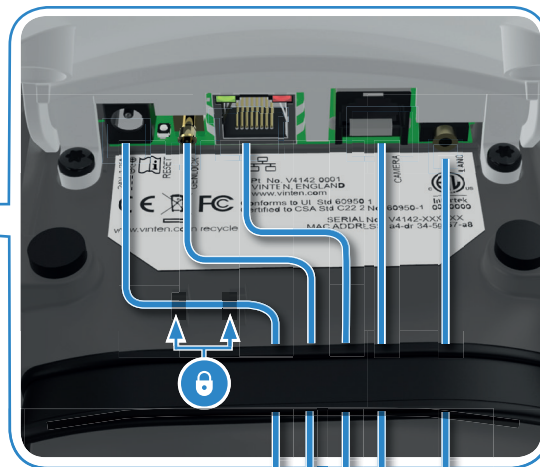

LANC

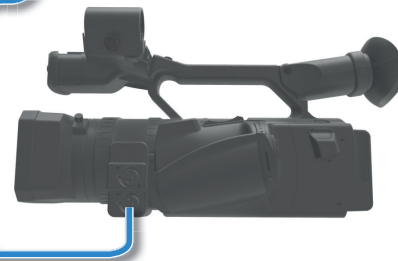

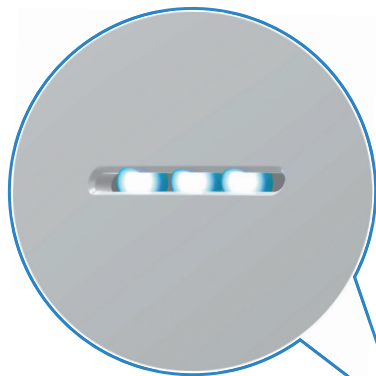
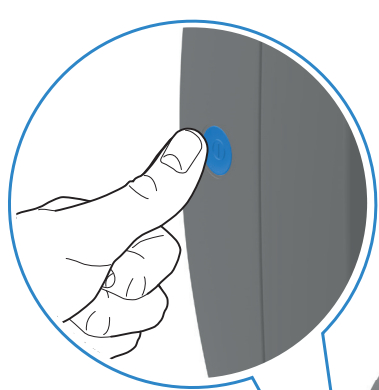

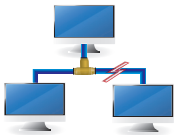
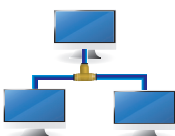
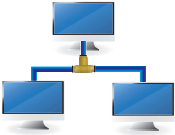



300 mm
(12 In.)



-20°C ↔ +60°C
(-4°F ↔ 140°F)



MIN. 0.02 Deg/s



400 mm
(15.7 In.)



355°

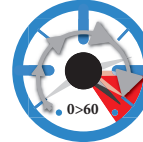

60 Deg/s²

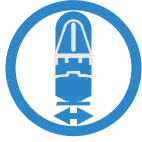

150 mm
(5.9 In.)



90°



0.2 Deg



7.5 kg
(16.5 lb)



24 V DC, 1.25 A



|0.2| Deg



4.5 kg
(9.9 lb)



24 W

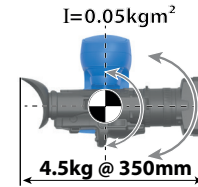

$I = 0.05 \text{ kgm}^2$

$I = 0.05 \text{ kgm}^2$
4.5kg @ 350mm



5°C ↔ +40°C
(41°F ↔ +104°F)



MAX. 60 Deg/s





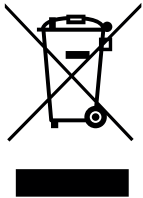

www.vinten.com/recycle



Vinten



Publication No.
V4142-4980/2

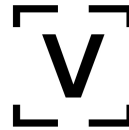

Vinten
A Videndum plc Brand